

# PREZENTACE SPOLEČNOSTI

Ing. Martin Vala

Elektro-optický specialista / Projektový manažer

 **EVPÚ DEFENCE**





## PROFIL SPOLEČNOSTI

- 85+ zaměstnanců
- 20+ let zkušeností
- 2019 rozšíření výrobních kapacit (plocha pro výrobu nyní cca 1600 m<sup>2</sup>)
- 5000+ polohovacích zařízení, 600+ EOS systémů
- 40+ zemí
- Zavedena v NATO
- Hlavní zákazníci: Policie ČR, Armáda ČR, Armáda SR, světoví vedoucí výrobci systémů





- **ISO 8 – měření, mechanické skládání, kalibrace a testování**
- **ISO 6 – výměna a údržba chladičů u chlazených kamer**
- **2 optické kolimátory pro optické kalibrace a přesná měření**
- **Teplotní komora s ovládáním vlhkosti**

# PŘEDSTAVENÍ SPOLEČNOSTI – VLASTNÍ LAKOVNA + CNC DÍLNA





## ZASTOUPENÍ ZAMĚSTNANCŮ (%)

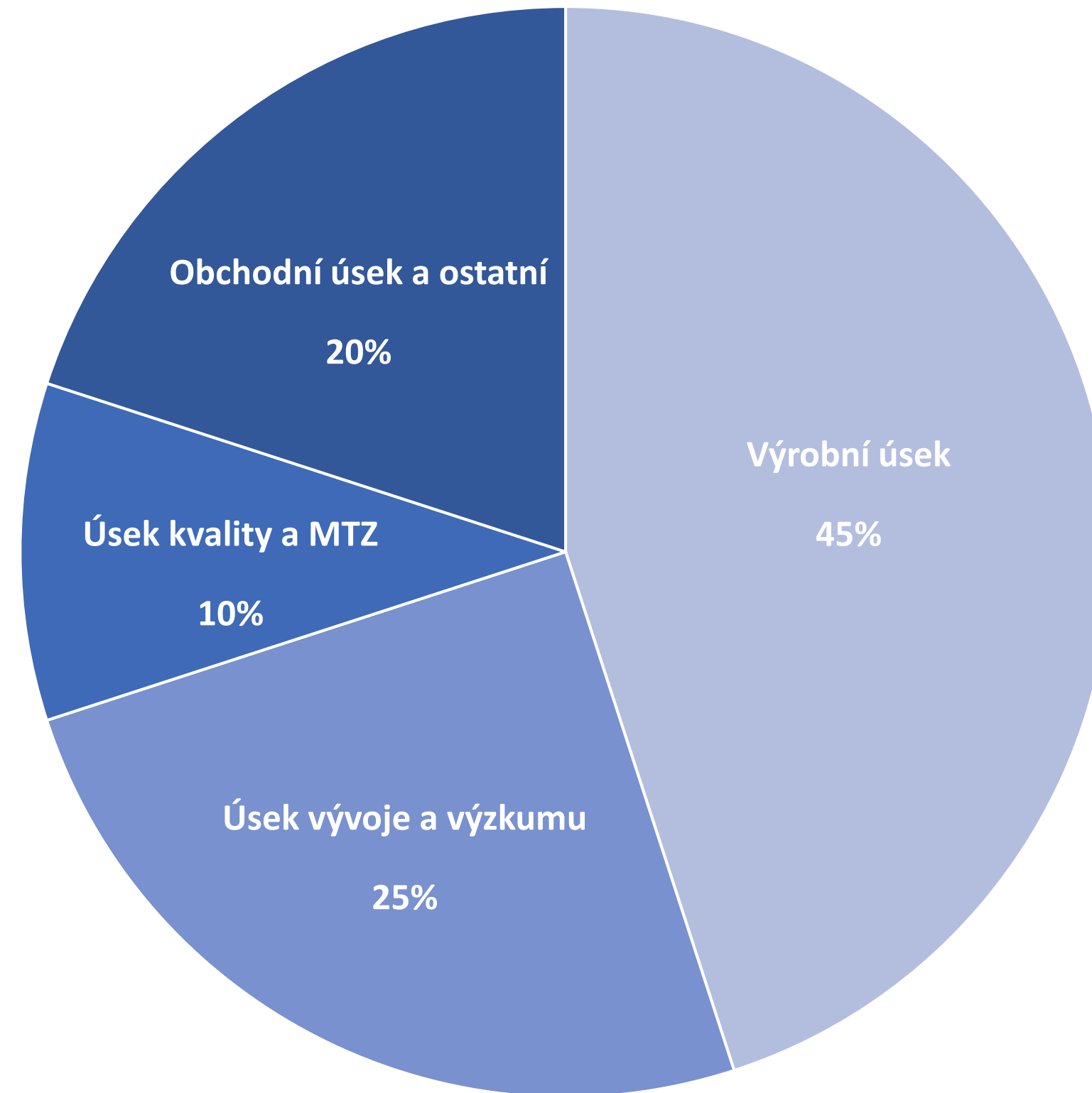



## ŘEŠENÍ NA KLÍČ

- **Předběžná analýza**
- **Zákaznické řešení**
- **Výroba**
- **Testování**
- **Instalace a zprovoznění**
- **Operátorská podpora**
- **Podpora a údržba během celé životnosti produktu**

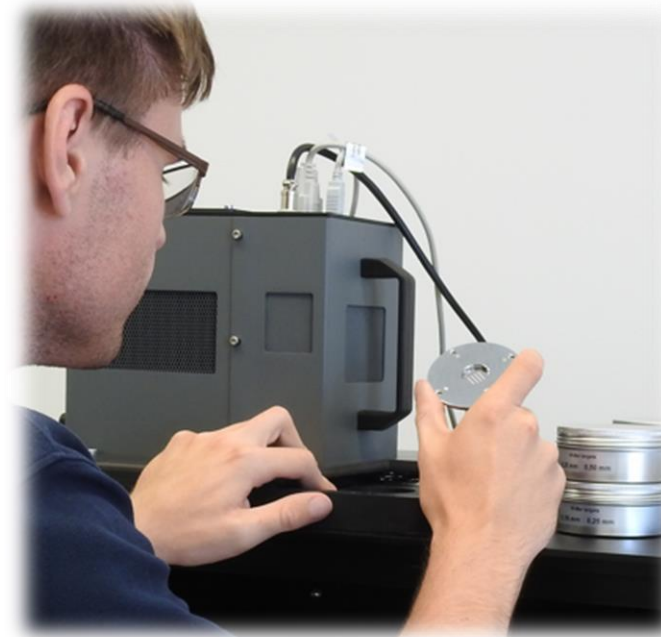

**R&D**



**Výroba**



**Kalibrace  
a testování**



**Servis  
a podpora 24/7**

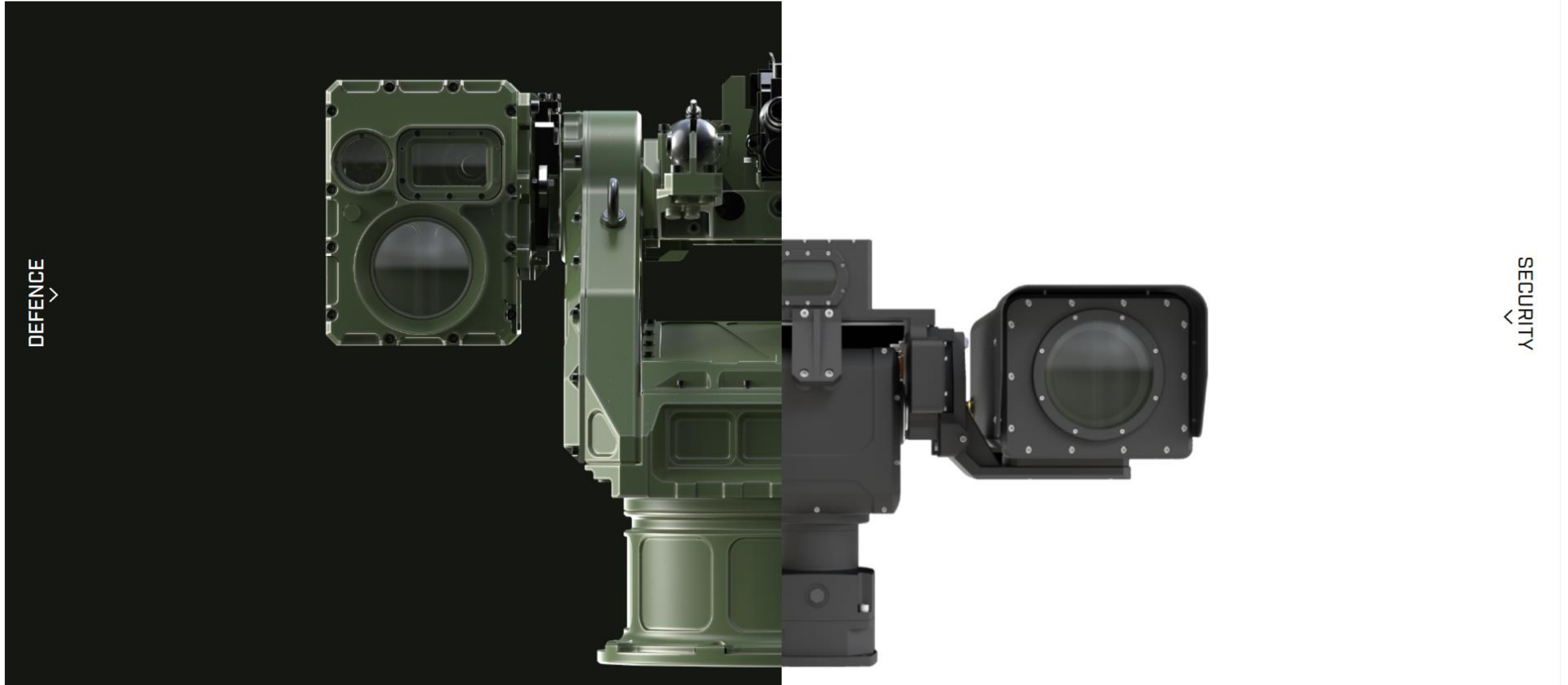



**Elektro-optické systémy  
(EOS)**



**Mobilní elektro-optické  
systémy**

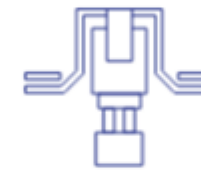

**Polohovací zařízení - pan  
tilts**



**Denní-noční a termovizní  
kamery**



**Příslušenství - SW, konzole  
operátora, kabely, GNSS,  
DMC, LRF, výsuvné sloupy**





- 18+ typů + možné modifikace
- 360° azimut, různé rozsahy elevace
- 24/7, nejméně 20 000 hodin MTBF
- IP 66-67
- V souladu s MIL-STD normami
- Možnost gyro-stabilizace





- Široká škála dosahů (DRI)
- Chlazené i nechlazené termální kamery
- 24/7
- IP 66
- V souladu s MIL-STD normami





- Věže
- Budovy
- Vozidla
- Čluny / Lodě

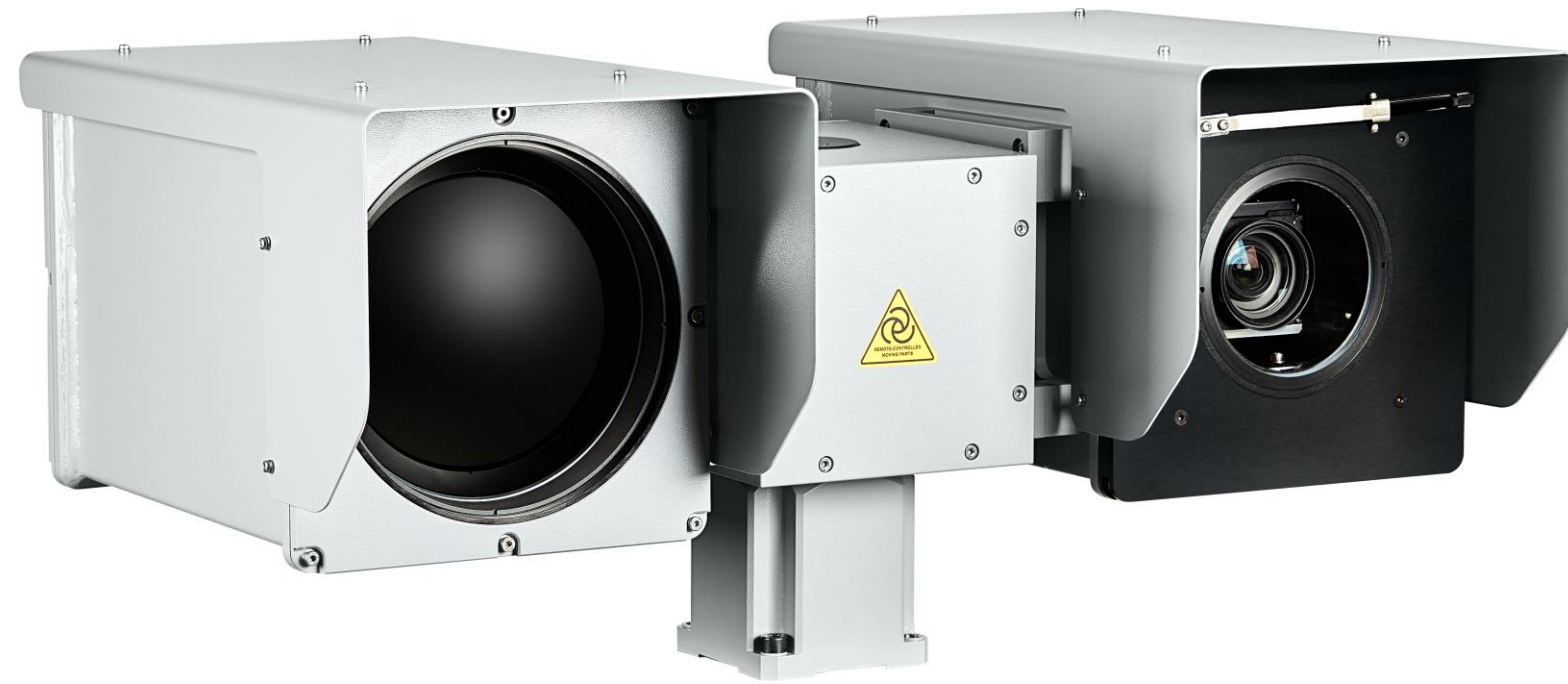

# MOBILNÍ ELEKTRO-OPTICKÉ SYSTÉMY





**Software  
CNS.NET**



**Software RCM**



**Konzole  
operátora CU-6**



**Kabely  
systémové a  
senzorové**



**Digitální  
magnetický  
kompas DMC**



**Laserový  
dálkoměr LRF**



**Navigace GNSS**



**Výsuvný  
elektrický sloup  
MAST**

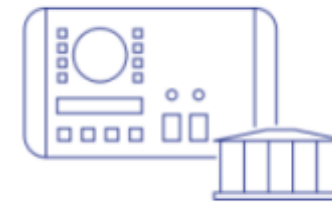

**System detekce  
laserového a radarového  
ozáření**

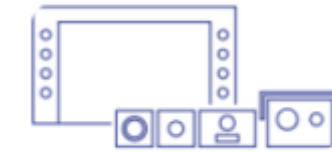

**Modulární systém ochrany  
perimetru**

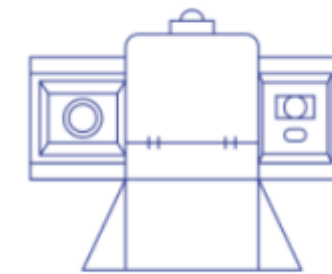

**Velitelský zaměřovač**

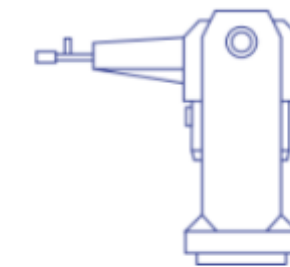

**Dálkově ovládané  
zbraňové stanice pro  
zbraně s ráží do 7,62 mm**



**Střelecké pozorovací  
zaměřovače**

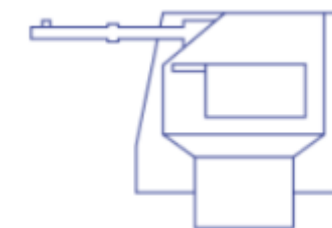

**Dálkově ovládané  
zbraňové stanice pro  
zbraně s ráží do 12,7 mm**



- **Velká variabilita a všestrannost**
- **Pro aplikace krátkých a středních dosahů**
- **Snadná integrace do zbraňových stanic RCWS**
- **MIL-STD 810 G**





- 360° azimut
- Systém pro střední dosahy
- Gyro stabilizace
- V souladu s MIL-STD normami
- Balistická ochrana úrovně 2  
(STANAG 4569 and AEP-55)





# ZBRAŇOVÉ STANICE MANTIS MINI do 7,62 MM a MANTIS do 12,7 MM



- Pro kulometry s ráží až do 7.62 mm nebo až do 12.7 mm
- Alternativně pro granátometry 30 / 40 mm
- 2 nezávislé stabilizované osy u MANTIS MINI
- 2+2 nezávislé stabilizované osy u MANTIS
- Výpočet balistiky součástí



# MODULÁRNÍ SYSTÉM OCHRANY PERIMETRU GATRIA



- 360° přehled o situaci na bojišti
- Modulární design
- Čistý a ostrý obraz ve dne i v noci
- Spolehlivá ochrana posádky i vozidla
- Z odolných modulů pro použití v podmínkách boje



## GATRIA

Modular  
Awareness  
System



AWIR 33



AWIR 11

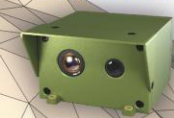

AWIR IR

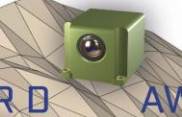

SEE & CHECK



AWIR D



AWIR D



+ up to 360° view  
of the battlefield  
+ modular design  
to suit your needs  
+ clear and sharp  
image

+ reliable crew and  
vehicle protection  
+ ruggedized modules  
for use under  
combat conditions

# SYSTEM DEKCE RADAROVÉHO A LASEROVÉHO OZÁŘENÍ LAWAREC



- Kombinace laserových a radarových detektorů
- Modulární design
- Spolupráce s odpalováním dýmových granátů
- Z odolných modulů





## PROJEKTY PRO POLICII ČR

- 30+ kusů SMV monitorovacích vozidel
- 6 kusů RBOX pozorovacích systémů



## PROJEKTY PRO ARMÁDU ČR

- 11 kusů zbraňových stanic pro kulomet s ráží 12,7 mm
- Modulární systémy ochrany perimetru GATRIA (Pandur, Titus, STARKOM)
- 80 kusů střeleckých zaměřovačů CRANE SR1G (vozidla CBRN)

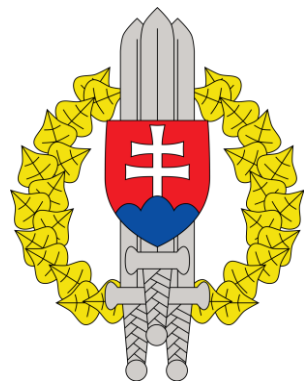

## PROJEKTY PRO ARMÁDU SR

- 68 kusů zaměřovačů CMS-1
- 68 kusů CRANE-XLR
- 72 setů LAWAREC
- 136 konzolí

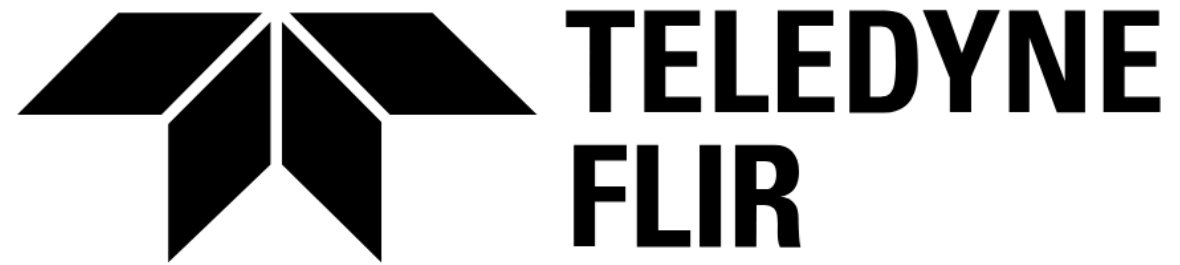

# REFERENCE – MONITOROVACÍ VOZIDLA S TERMOVIZÍ SMV



# REFERENCE – RCWS MANTIS MINI



# DĚKUJI ZA POZORNOST



EVPÚ Defence a.s.  
Jaktáře 1781  
686 01 Uherské Hradiště  
Česká Republika